

CONSTRUCTION DIAGRAM

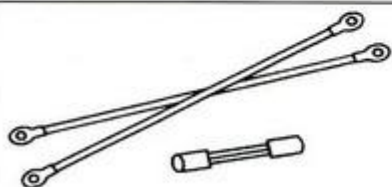
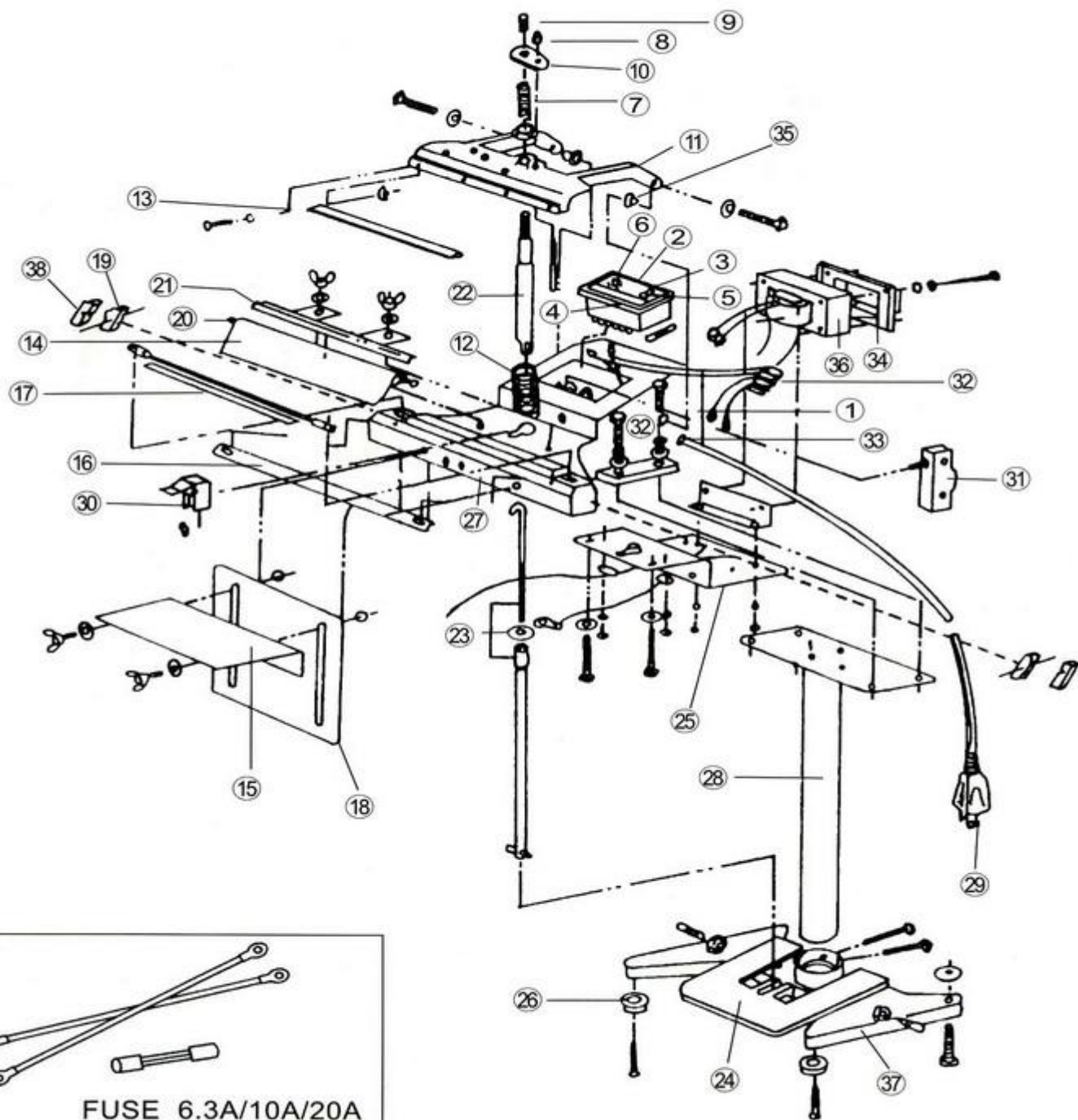

FUSE 6.3A/10A/20A

Model	300FI/305FI/3010FI	450FI/455FI/4510FI	600FI/605FI/6010FI	800FI/805FI
Max.Seal Length	300mm(12")	450mm(18")	600mm(24")	800mm(32")
Max.Seal Thickness	2x0.25mm	2x0.25mm	2x0.25mm	2x0.25mm
Seal Width	2mm/5mm/10mm	2mm/5mm/10mm	2mm/5mm/10mm	2mm/5mm
Heat Timer	0.3~2.0sec	0.2~2.0sec	0.2~2.0sec	0.2~2.0sec
Watts	450W/900W/1100W	600W/1200W/1500W	800W/1500W/1900W	1000W/1800W
Weight	20Kg/21Kg/22Kg	21Kg/22Kg/23Kg	23Kg/24Kg/25Kg	25Kg/26Kg

IMPULSE FOOT SEALER

300FI,450FI,600FI,800FI
 305FI,455FI,605FI,805FI
 3010FI,4510FI,6010FI

INSTRUCTION

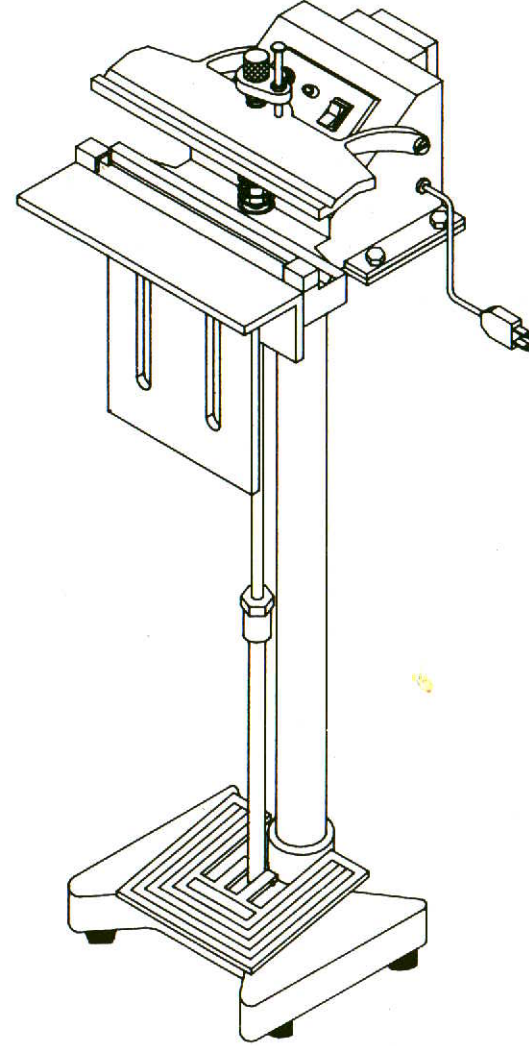

CONSTRUCTION DIAGRAM

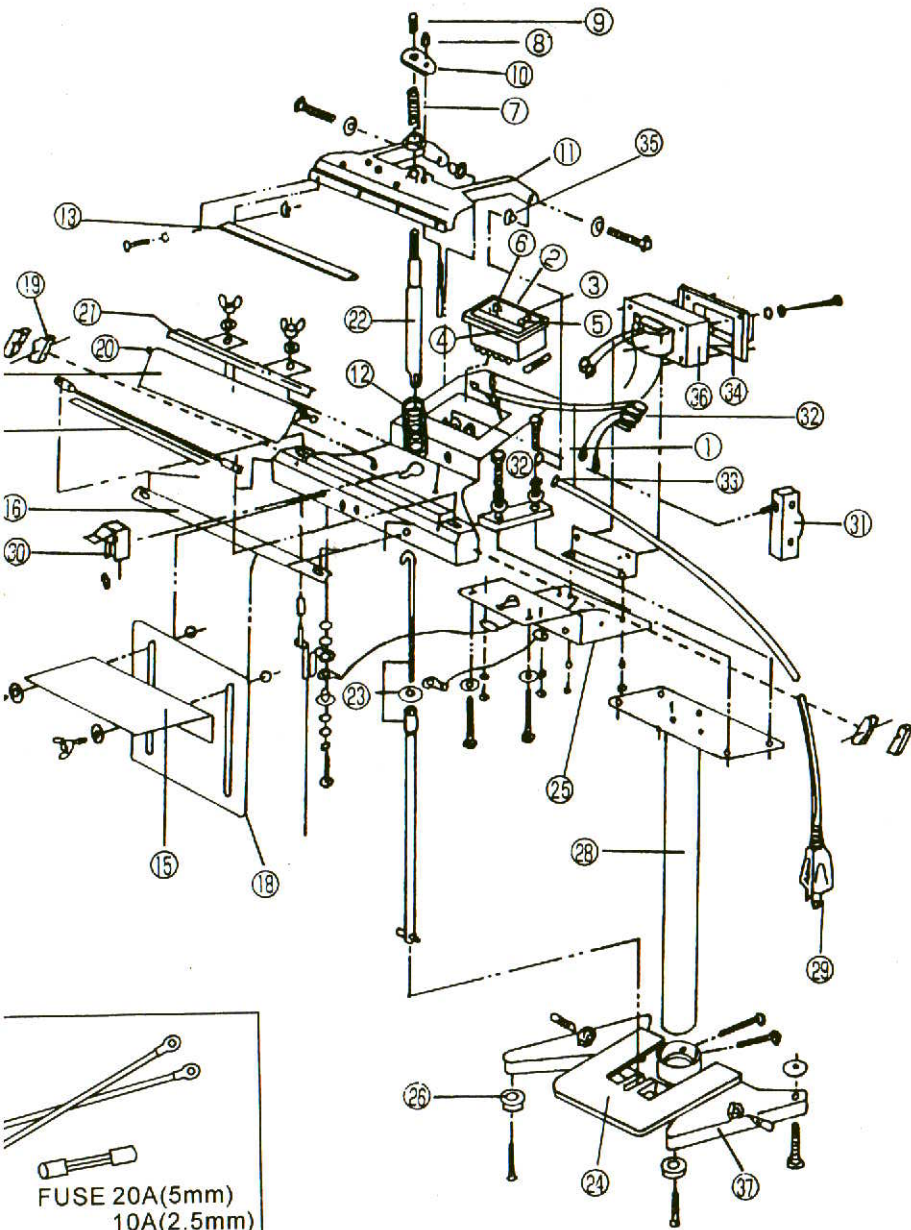

1

2 PARTS LIST

- 1. ENCLOSURE
- 2. TIMER CONTROL
- 3. PILOT LAMP
- 4. FUSEHOLDER
- 5. POWER SWITCH
- 6. TIMER KNOB
- 7. PRESSING SPRING
- 8. SETTING BOLT NUT
- 9. UPPER LEVER NUT
- 10. FIX PLATE
- 11. UPPER JAW
- 12. UPPER JAW SPRING
- 13. SILICONE RUBBER PAD
- 14. UPPER TEFLON CLOTH
- 15. WORKING PLATE
- 16. UPPER CLOTH FIX PLATE
- 17. LOWER HEATER CLOTH
- 18. LEVEL PLATE
- 19. HEATING TERMINAL ASSEMBLY
- 20. METAL BAR FOR CLOTH
- 21. CLIP FOR TEFLON CLOTH
- 22. UPPER LEVER
- 23. DOWN LEVER
- 24. FOOT PEDAL
- 25. BOTTOM COVER PLATE
- 26. RUBBER FOOT
- 27. RELAY
- 28. STANDING TUBE
- 29. POWER SUPPLY CORD
- 30. INTERLOCK SET
- 31. LIMITED SWITCH
- 32. CONNECTOR
- 33. STRAIN RELIEF BUSHING
- 34. TRANSFORMER COVER
- 35. HINGE FOR UPPER JAW
- 36. TRANSFORMER
- 37. PEDAL BASE

3 CONNECTION DIAGRAM

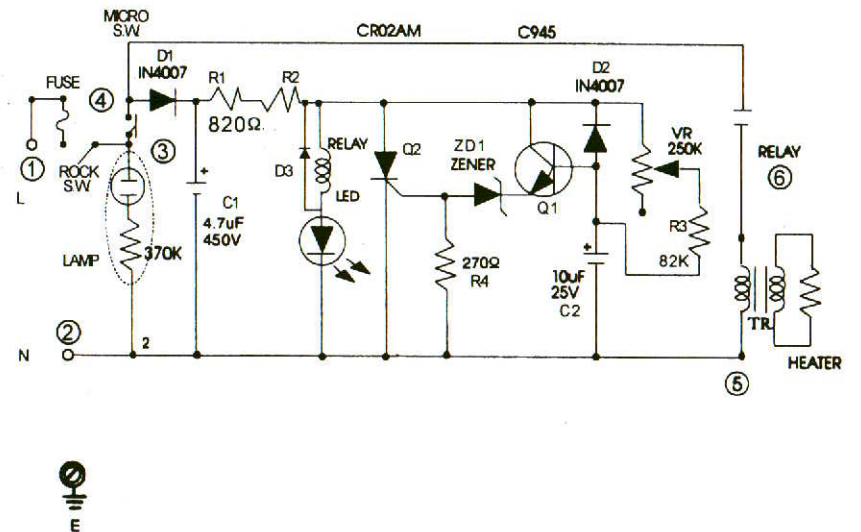

2

4. HELPFUL INFORMATION

- Always keep the sealing platform clean. Particular care 'should' be taken to remove any residue from the teflon tape.
- Do not clean the sealing platform with anything wet.
- Make sure to change the upper teflon tape (above the element wire) and the lower teflon strip (below the element wire) when they become worn. If this is not done, the element wire may short out and become damaged.
- When replacing the heating element always check the condition of the bottom teflon tape. It is important that you replace the element wire only with the one made for this machine. You can damage the transformer with the wrong element wire.
- Occasionally check the condition of the top pressure pad (silicon rubber) for wear or burn. A poor rubber pad will effect the quality of your seal.

USE ONLY GENUINE REPLACEMENT PARTS

5. CHANGING PARTS

To replace burnt out teflon tape or broken element wires please follow these instructions:

REMOVE PLUG FROM ELECTRIC OUTLET.

1. To replace Teflon
 - (a) Remove pressing plate. Loosen teflon clips.

- (b) Pull out teflon tape just enough to cut off burned area. Smooth out teflon and refix the pressing plate.
- (c) Rotate teflon screw to pull teflon tight. Retighten the teflon clips.

2. Replacing heating element wire

- (a) Loosen teflon clips. Remove pressing plate.
- (b) Lift up teflon and remove broken element wire from element locks.
- (c) Put new element wire on element locks. Do not bend or crimp the wire.
- (d) Replace teflon and pressing plate. Tighten teflon with teflon screw. Tighten teflon clips.

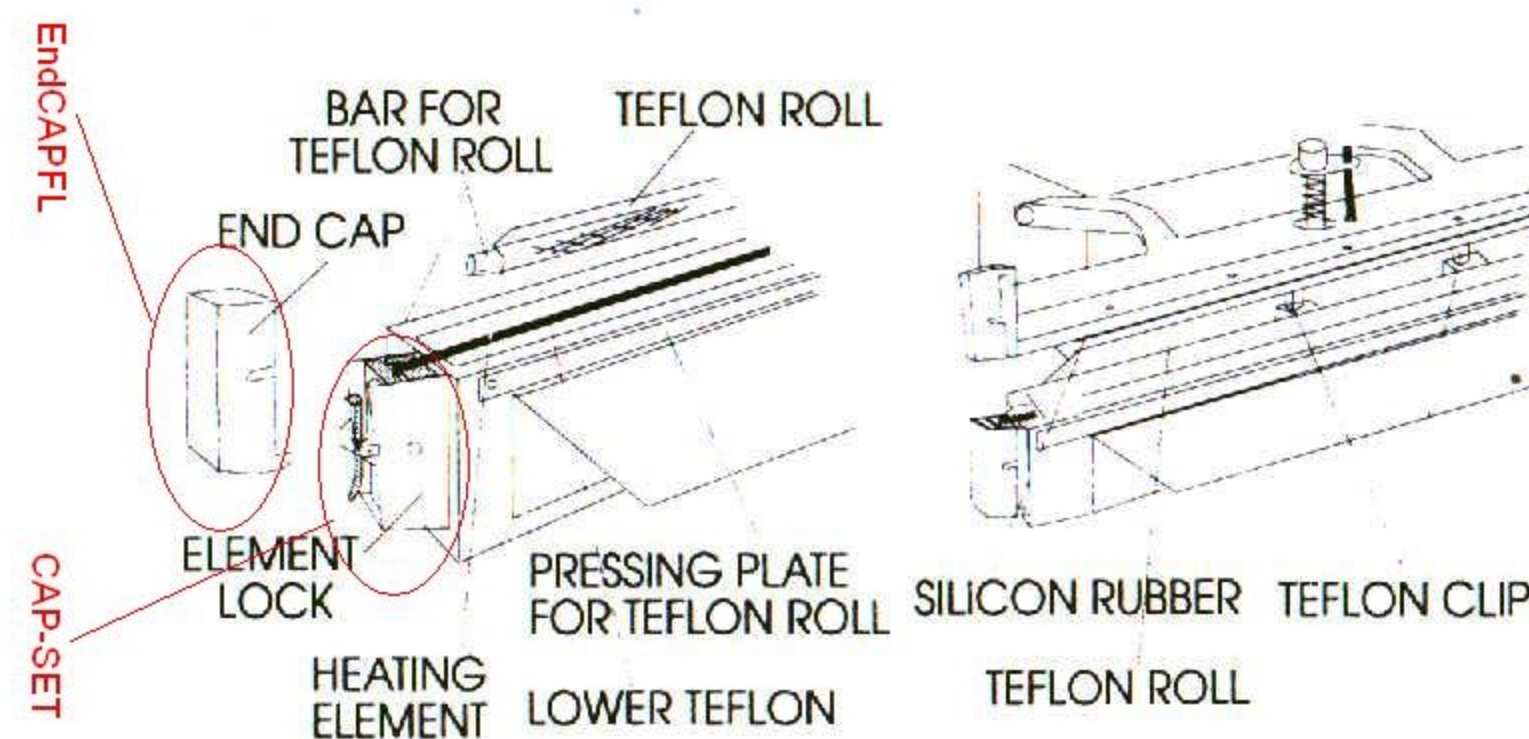

6 CAUTIONARY MARKINGS

- CAUTION** -To reduce the risk of shock, disconnect the unit from the supply circuit before servicing the replacement of the heating element.
- To provide continued protection against risk of electric shock, connect to properly grounded outlet only.
 - A live heating element is located in the arm under the teflon tape. Use caution during operation. DO NOT TOUCH THE ELEMENT.
- WARNING** -For Continued Protection Against Fire or Electric shock, Replace Only With Type Cartridge and 10 Ampere Fuse. Provided in legible adjacent to fuseholder. (Only 300 FI, 450FI, 600 FI)
- Close supervision is required when the product is used near children.

ASSEMBLING FOR FOOT SEALER

- (1). Insert standing tube into pedal base and connect with short screw.

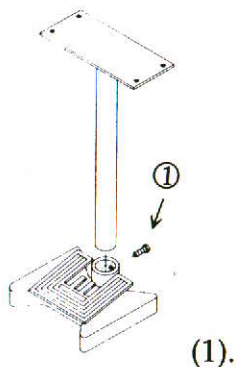

- (2). With four long screws connect body to stand.

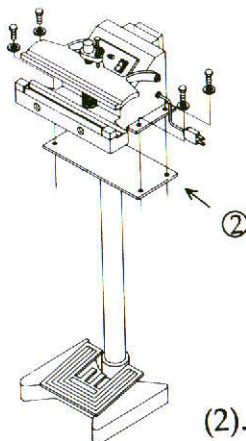

- (3). Attach puller rod to puller (located under base) and then attach to foot pedal.

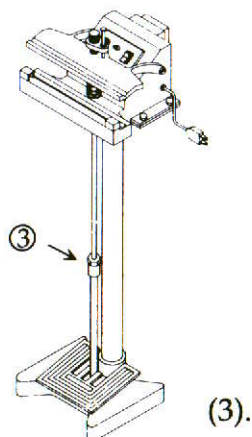

- (4) & (5) Connect working plate fixed bracket to body. Fit working plate over bracket.

Note: When attaching working plate bracket leave enough space between sealer body and top of screws so that working plate can be attached easily.

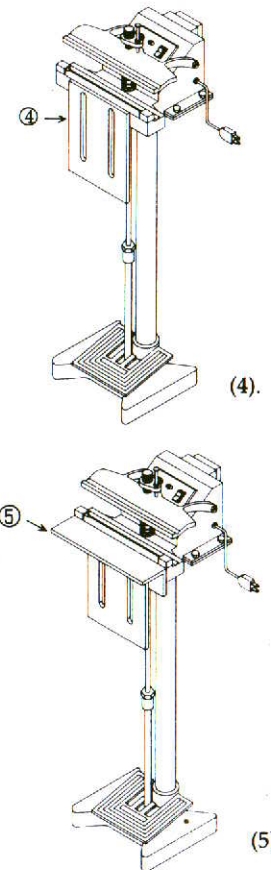

8 OPERATING INSTRUCTIONS

After the machine is fully assembled and plugged into a outlet, do the following:

1. Adjust the foot pedal rod (#23 down lever) to obtain a firm contact of the jaws.
2. Push the on / off switch(#5) to ON position.
3. Turn the timing knob(#6) to the lowest number and press the foot pedal down. The little neon light(#3) will go on for less than a second, this is the sealing time. Hold the pedal down for another second, this is the cooling-down time.
4. If it does not complete with the seal, turn the timing knob up a little and go through process in 3. Keep increasing the number until you get the desired seal. Then leave it alone.
5. FOR SAFETY SAKE" KEEP HANDS AND FINGERS FROM BETWEEN THE JAWS WHEN SEALING.

TURN MACHINE OFF WHEN NOT IN USE.

No.	Description	Part Number	No.	Spare Parts	Part Number
1	Enclosure Body	*BODY-AFI	1	40" Stand Extension	AIE-FSX2
2	Control Panel	*TI450FIT	2	Relay	*RELAY-F
3	Sealing Pilot Lamp		3	Fuse 15A/6.3A/10A/20A	*FUSE-F
4	Fuse Holder	*FUSEBOXF	4	Micro Switch	*MICRO-FL
5	Power Main Switch	*ROCKERSW			
6	Timer Control Knob	*KNOB			
7	Pressing Spring	*JAWSP-L1			
8	Setting Bolt Nut	*SET-BOLT			
9	Upper Lever Nut	*PULLER			
10	Fixing Lever Plate	*PLATE#10			
11	Upper Sealing Jaw	*JAW-AFI			
12	Return Spring	*JAWSP-L			
13	Sealing Silicon Rubber	*SR450FIT			
14	Teflon Cloth	*TFS450			
15	Working Plate	*TA450FL			
16	Fixed Teflon Cloth Plate	*TFP450FIT			
17	Teflon Sheet Strip	*TFL450FIT			
18	Working Adjust Plate	*LEVELP			
19	Heater Terminal Assembly	*CAPSETFI			
20	Screw for Teflon Cloth	*SCREW#20			
21	Clip for Teflon Cloth	*CLIP300F			
22	Upper Lever	*ROD			
23	Down Lever	*ROD			
24	Foot Pedal	*BOARD-N			
25	Bottin Cover				
26	Rubber Foot	*FOOT-F			
27	Lower Sealing Jaw	*BODXB30			
28	Standing Tube	*STAND			
29	Power Plug	*CORD-AF			
30	InterLock Set	*INTLOCK			
31	Limited Switch	*MICRO-FL			
32	PCB Connector	*CONNECTF			
33	Strain Relief Bushing	*CORDHO-F			
34	Transformer Cover	*TRCOVER			
35	Flange For Upper Jaw	*FLANGE-F			
36	Transformer	*TR450FIT			
37	Pedal Base	*BASE			
38	End Cover	*ENDCAPFI			